



2SK3820

N-Channel Power MOSFET 100V, 26A, 60mΩ, TO-263-2L

ON Semiconductor®

<http://onsemi.com>

Features

- ON-resistance $R_{DS(on)} = 45m\Omega$ (typ.)
- Input capacitance $C_{iss} = 2150pF$ (typ.)
- 4V drive

Specifications

Absolute Maximum Ratings at $T_a = 25^\circ C$

Parameter	Symbol	Conditions	Ratings	Unit
Drain-to-Source Voltage	V_{DSS}		100	V
Gate-to-Source Voltage	V_{GSS}		± 20	V
Drain Current (DC)	I_D		26	A
Drain Current (Pulse)	I_{DP}	$PW \leq 10\mu s$, duty cycle $\leq 1\%$	104	A
Allowable Power Dissipation	PD		1.65	W
		$T_c = 25^\circ C$	50	W
Channel Temperature	T_{ch}		150	$^\circ C$
Storage Temperature	T_{stg}		-55 to +150	$^\circ C$
Avalanche Energy (Single Pulse) *1	E_{AS}		84.5	mJ
Avalanche Current *2	I_{AV}		26	A

Note : *1 $V_{DD} = 20V$, $L = 200\mu H$, $I_{AV} = 26A$ (Fig.1)

*2 $L \leq 200\mu H$, single pulse

Stresses exceeding Maximum Ratings may damage the device. Maximum Ratings are stress ratings only. Functional operation above the Recommended Operating Conditions is not implied. Extended exposure to stresses above the Recommended Operating Conditions may affect device reliability.

Package Dimensions

unit : mm (typ)

7535-001

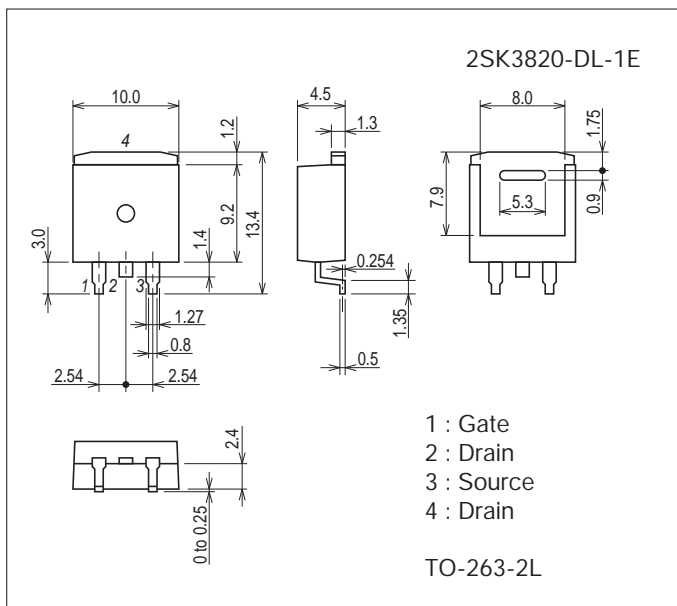

Ordering & Package Information

Device	Package	Shipping	memo
2SK3820-DL-1E	TO-263-2L (SC-83, TO-263)	800pcs./reel	Pb Free

Packing Type: DL

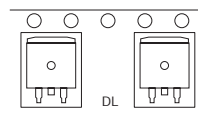

Marking

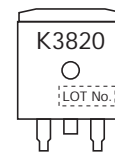

Electrical Connection

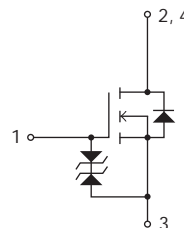

Electrical Characteristics at Ta=25°C

Parameter	Symbol	Conditions	Ratings			Unit
			min	typ	max	
Drain-to-Source Breakdown Voltage	V(BR)DSS	ID=1mA, VGS=0V	100			V
Zero-Gate Voltage Drain Current	IDSS	VDS=100V, VGS=0V			1	μA
Gate-to-Source Leakage Current	IGSS	VGS=±16V, VDS=0V			±10	μA
Cutoff Voltage	VGS(off)	VDS=10V, ID=1mA	1.2		2.6	V
Forward Transfer Admittance	yfs	VDS=10V, ID=13A	11	19		S
Static Drain-to-Source On-State Resistance	RDS(on)1	ID=13A, VGS=10V		45	60	mΩ
	RDS(on)2	ID=13A, VGS=4V		56	80	mΩ
Input Capacitance	Ciss	VDS=20V, f=1MHz		2150		pF
Output Capacitance	Coss			160		pF
Reverse Transfer Capacitance	Crss			110		pF
Turn-ON Delay Time	td(on)	See Fig.2		20		ns
Rise Time	tr			34		ns
Turn-OFF Delay Time	td(off)			185		ns
Fall Time	tf			62		ns
Total Gate Charge	Qg	VDS=50V, VGS=10V, ID=26A		44		nC
Gate-to-Source Charge	Qgs			7.8		nC
Gate-to-Drain "Miller" Charge	Qgd			9.8		nC
Diode Forward Voltage	VSD	IS=26A, VGS=0V		1.0	1.2	V

Fig.1 Unclamped Inductive Switching Test Circuit

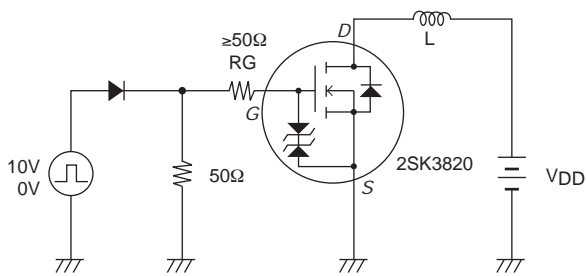
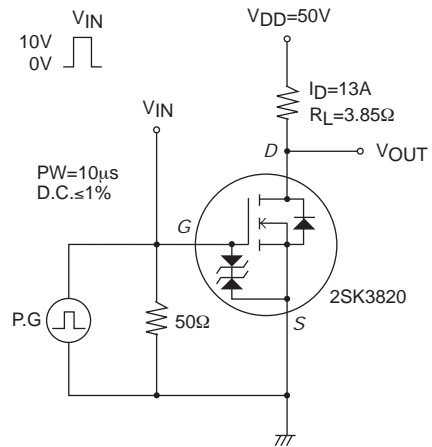
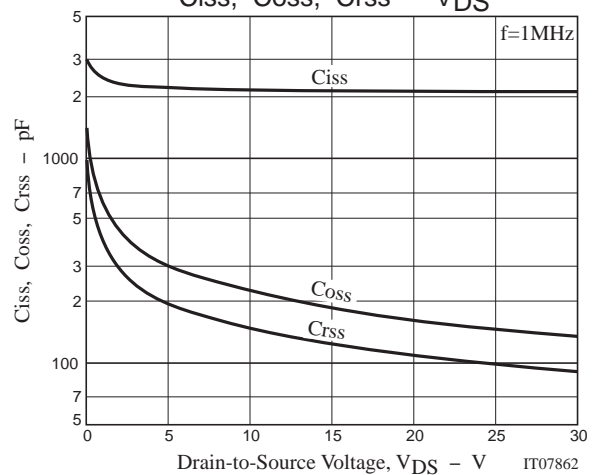
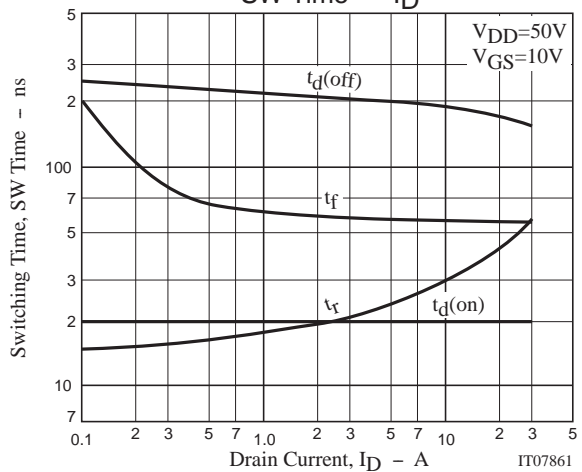
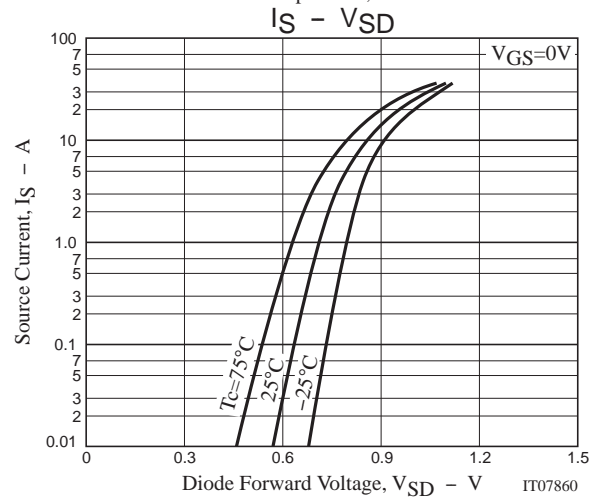
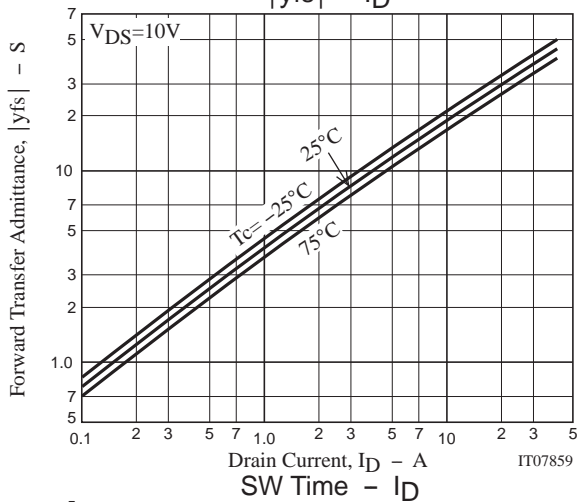
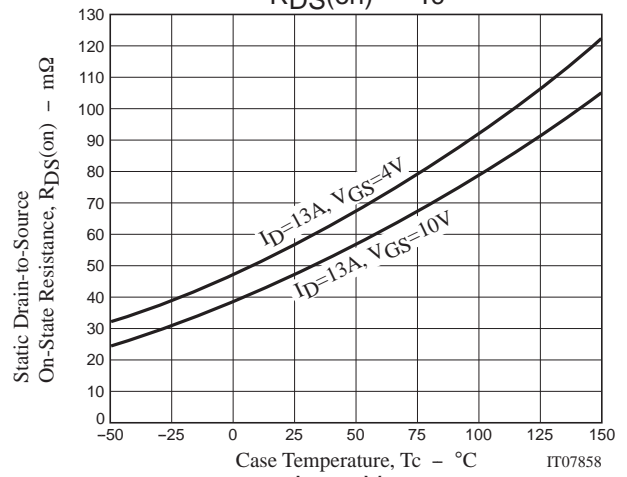
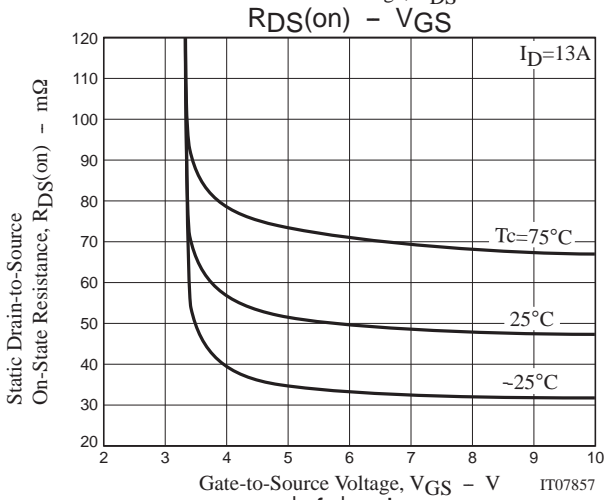
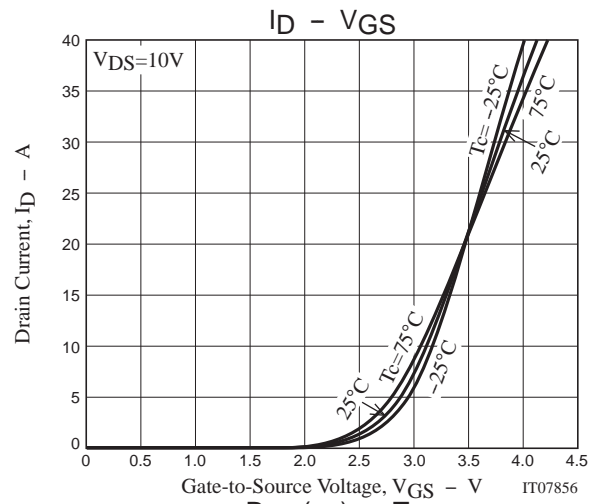
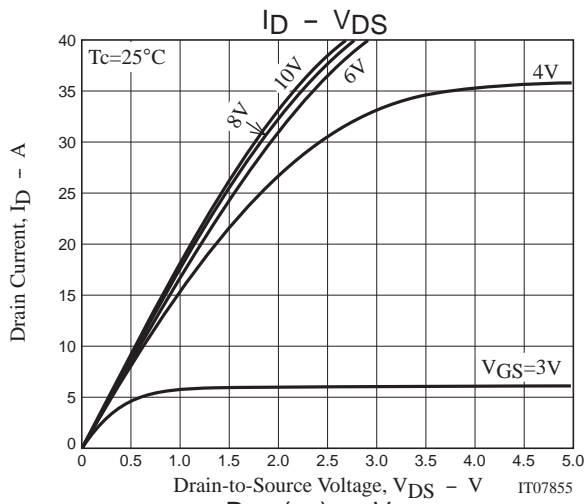
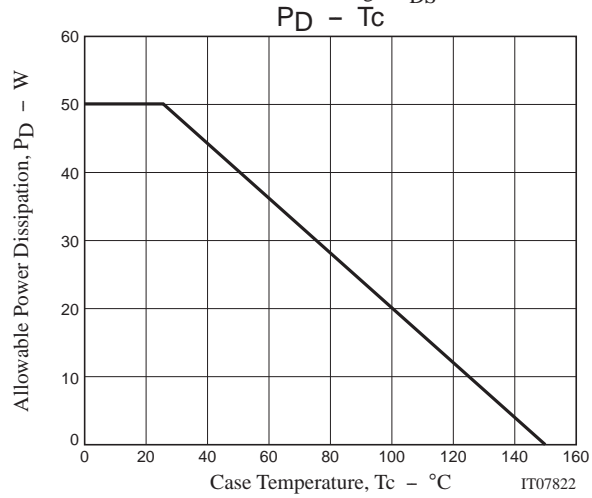
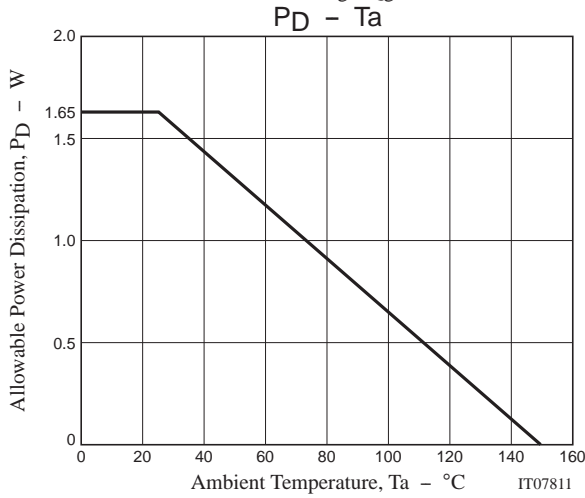
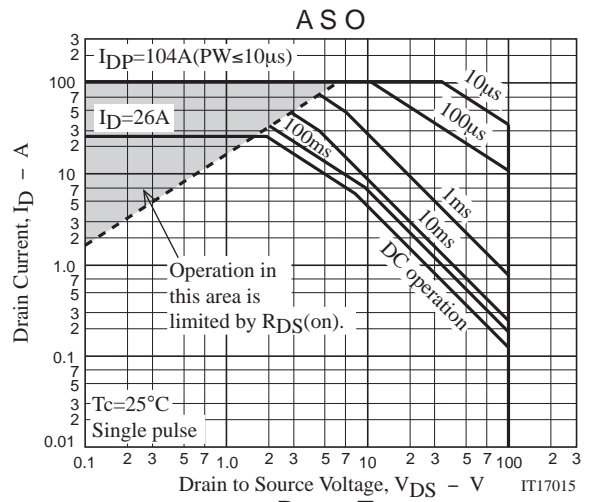
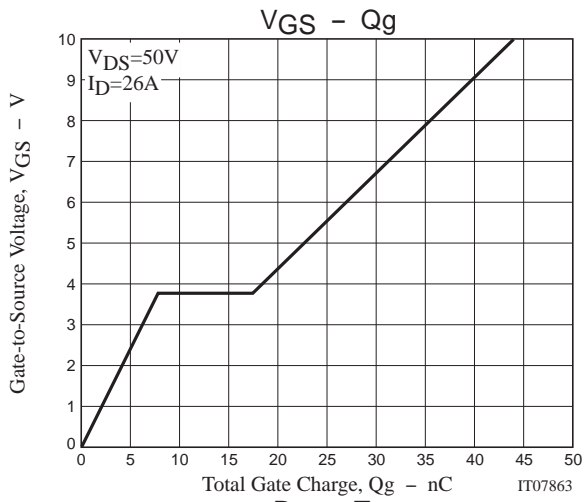

Fig.2 Switching Time Test Circuit







2SK3820

Outline Drawing 2SK3820-DL-1E

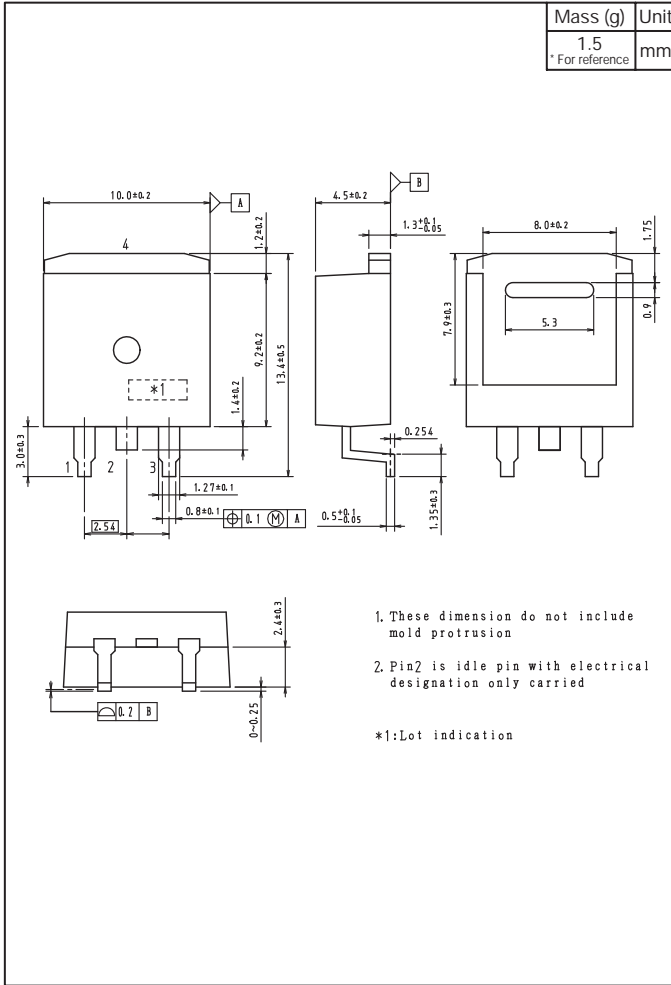

Land Pattern Example

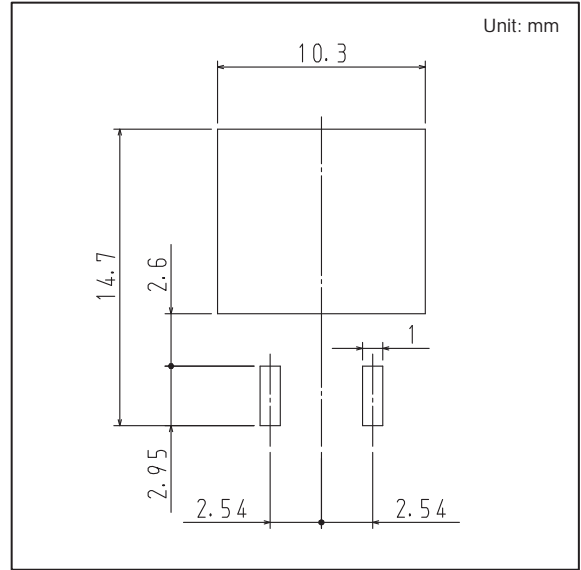

Note on usage : Since the 2SK3820 is a MOSFET product, please avoid using this device in the vicinity of highly charged objects.

ON Semiconductor and the ON logo are registered trademarks of Semiconductor Components Industries, LLC (SCILLC). SCILLC owns the rights to a number of patents, trademarks, copyrights, trade secrets, and other intellectual property. A listing of SCILLC's product/patent coverage may be accessed at www.onsemi.com/site/pdf/Patent-Marking.pdf. SCILLC reserves the right to make changes without further notice to any products herein. SCILLC makes no warranty, representation or guarantee regarding the suitability of its products for any particular purpose, nor does SCILLC assume any liability arising out of the application or use of any product or circuit, and specifically disclaims any and all liability, including without limitation special, consequential or incidental damages. "Typical" parameters which may be provided in SCILLC data sheets and/or specifications can and do vary in different applications and actual performance may vary over time. All operating parameters, including "Typicals" must be validated for each customer application by customer's technical experts. SCILLC does not convey any license under its patent rights nor the rights of others. SCILLC products are not designed, intended, or authorized for use as components in systems intended for surgical implant into the body, or other applications intended to support or sustain life, or for any other application in which the failure of the SCILLC product could create a situation where personal injury or death may occur. Should Buyer purchase or use SCILLC products for any such unintended or unauthorized application, Buyer shall indemnify and hold SCILLC and its officers, employees, subsidiaries, affiliates, and distributors harmless against all claims, costs, damages, and expenses, and reasonable attorney fees arising out of, directly or indirectly, any claim of personal injury or death associated with such unintended or unauthorized use, even if such claim alleges that SCILLC was negligent regarding the design or manufacture of the part. SCILLC is an Equal Opportunity/Affirmative Action Employer. This literature is subject to all applicable copyright laws and is not for resale in any manner.